

PARAGARD® 사용을 고려 중이십니까?
(동제 자궁 내 피임장치)

PARAGARD® intrauterine copper contraceptive



유일하게 100% 무호르몬인 IUD(자궁 내 피임장치)입니다!

PARAGARD란?

PARAGARD는 자궁 내에 삽입되어 구리를 배출함으로써 최대 10년까지 임신을 방지하는 장치입니다. 이는 자궁 내 장치(Intrauterine Device, IUD)라고도 불리는 피임 방법입니다.

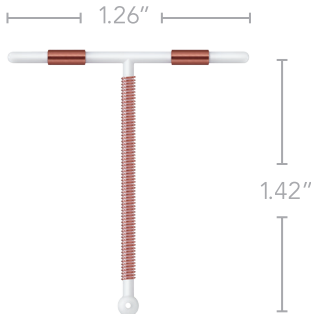

실제 크기.

PARAGARD의 작용 방법

PARAGARD는 T 모양의 장치로, 주로 부드럽고 유연한 플라스틱과 구리로 만들어집니다. PARAGARD에 포함된 구리가 효과를 높여줍니다. 이는 정자의 움직임, 난자의 수정을 방해하고 착상을 방지할 수 있습니다. 병원 정기 방문 시 담당 의료 전문가가 PARAGARD를 자궁에 삽입합니다.

무료로 PARAGARD 시술을 받으실 수도 있습니다!

부담적정보험법(Affordable Care Act) 덕분에 자격이 있는 여성은 PARAGARD를 코페이, 공제액 또는 자기부담금 없이* 시술 받을 수 있습니다.

*보험 제공자와 확인하십시오.



99% 이상 효과를 보이는 100% 무호르몬 장치



1년 내 이든 10년 내 이든 고객이 원하는 때에 의료진이 제거 가능



임신을 결정할 경우, 의료진이 PARAGARD를 제거한 당일 임신 시도 가능



30년 이상 FDA에서 승인하고 수백만 명의 여성이 사용 중인 제품

중요 안전 정보

골반염이 있거나 감염에 취약하거나 특정 암이 있을 경우 PARAGARD를 사용하지 마십시오. 1% 미만의 사용자는 골반내 염증성 질환이라는 심각한 질환에 걸릴 수 있습니다. 지속적인 골반 또는 복부 통증이 있을 경우나 PARAGARD가 배출될 경우, 의료 전문가에게 알려십시오. 배출될 경우에는 대체 피임 도구를 사용하십시오.

뒷면의 추가 중요 안전 정보와 동봉된 처방 정보 전문을 참고하십시오.

PARAGARD® 시술 받기

(동제 자궁 내 피임장치)

PARAGARD의 피임 효과는
99% 이상 효과적이며 100% 무호르몬입니다.

시술

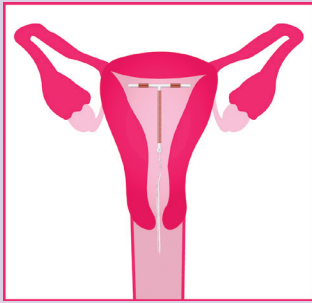

일반적으로 PARAGARD 삽입에는 수 분이 소요됩니다. 수술은 필요하지 않으며 병원 정기 방문 시 담당 의료 전문가가 실시할 수 있습니다.

어지러움, 메스꺼움 또는 현기증을 느낄 수 있습니다. 의료 전문가는 얼마간 누워있다가 천천히 일어나도록 지시할 것입니다. 또한 시술 중에 꼬집는 느낌이나 경련이 느껴질 수 있습니다.

의료 전문가가 PARAGARD를 삽입한 후에는 아무 느낌도 나지 않을 것입니다. PARAGARD는 자궁에 안전하게 장착되기 때문에, 탐폰도 사용할 수 있고 파트너 역시 성관계 도중 아무것도 느끼지 못할 것입니다.

PARAGARD의 특징은 아래와 같습니다.

0회 번거로운 **일상 확인** 또는 처방약 제조

1회 월간 추적 검사

2회 방문 일정(시작 시) — 장치 삽입을 위한 1회 방문, 1개월 후 올바른 위치에 삽입되었는지 확인을 위한 1회 방문*

*개인에 따라 PARAGARD가 정확한 위치에 있는지 확인하기 위해 추가 방문이 필요할 수 있습니다.

중요 안전 정보(계속)

PARAGARD는 종종 자궁벽에 붙거나 아주 드문 경우 자궁벽을 통과해 기타 문제를 일으킬 수 있습니다. 일부의 경우 수술을 통한 제거가 필요할 수 있습니다. 흔하지는 않지만, PARAGARD를 임신 중에 사용하는 것은 생명에 위협을 줄 수 있으며 유산 또는 불임을 초래할 수 있습니다. 처음에는 출혈 또는 점상출혈이 있을 수 있으나, 2~3개월 이내에 감소합니다. **PARAGARD는 HIV/AIDS 또는 성행위로 전파되는 질환(Sexually Transmitted Diseases, STD)을 예방할 수 없습니다.**

처방으로만 구입 가능합니다.

처방약에 대한 부작용은 언제나 FDA 웹 사이트 www.fda.gov/medwatch를 방문하시거나 1-800-FDA-1088번으로 전화하여 신고해 주십시오.

뒷면의 추가 안전 정보를 확인하십시오.

동봉된 처방 정보 전문을 확인하십시오.

**ParaGard® T 380A
INTRAUTERINE COPPER CONTRACEPTIVE**

P/N 1017005
Rev. 9/2014

Rx only

PRESCRIBING INFORMATION

ParaGard® T 380A Intrauterine Copper Contraceptive

Patients should be counseled that this product does not protect against HIV infection (AIDS) and other sexually transmitted diseases.

ParaGard® T 380A Intrauterine Copper Contraceptive should be placed and removed only by healthcare professionals who are experienced with these procedures.

DESCRIPTION

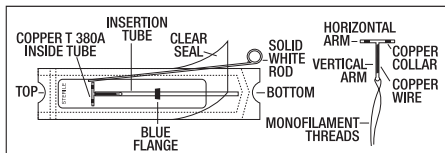

ParaGard® T 380A Intrauterine Copper Contraceptive (ParaGard®) is a T-shaped intrauterine device (IUD), measuring 32 mm horizontally and 36 mm vertically, with a 3 mm diameter bulb at the tip of the vertical stem. A monofilament polyethylene thread is tied through the tip, resulting in two white threads, each at least 10.5 cm in length, to aid in detection and removal of the device. The T-frame is made of polyethylene with barium sulfate to aid in detecting the device under x-ray. ParaGard® also contains copper: approximately 176 mg of wire coiled along the vertical stem and a 68.7 mg collar on each side of the horizontal arm. The total exposed copper surface area is 380 ± 23 mm². One ParaGard® weighs less than one (1) gram. No component of ParaGard® or its packaging contains latex.

ParaGard® is packaged together with an insertion tube and solid white rod in a Tyvek® polyethylene pouch that is then sterilized. A moveable flange on the insertion tube aids in gauging the depth of insertion through the cervical canal and into the uterine cavity.

CLINICAL PHARMACOLOGY

The contraceptive effectiveness of ParaGard® is enhanced by copper continuously released into the uterine cavity. Mechanism(s) by which copper enhances contraceptive efficacy include interference with sperm transport and fertilization of an egg, and possibly prevention of implantation.

INDICATIONS AND USAGE

ParaGard® is indicated for intrauterine contraception for up to 10 years. The pregnancy rate in clinical studies has been less than 1 pregnancy per 100 women each year.

Table 1: Percentage of women experiencing an unintended pregnancy during the first year of typical use and first year of perfect use of contraception and the percentage continuing use at the end of the first year: United States

Method (1)	% of Women Experiencing an Accidental Pregnancy within the First Year of Use		% of Women Continuing Use at One Year ³
	Typical Use ¹ (2)	Perfect Use ² (3)	
Chance ⁴	85	85	
Spermicides ⁵	26	6	40
Periodic Abstinence	25		63
Calendar		9	
Ovulation Method		3	
Sympto-thermal ⁶		2	
Post-ovulation		1	
Cap ⁷			
Parous women	40	26	42
Nulliparous women	20	9	56
Sponge			
Parous women	40	20	42
Nulliparous women	20	9	56
Diaphragm ⁷	20	6	56
Withdrawal	19	4	
Condom ⁸			
Female (Reality)	21	5	56
Male	14	3	61
Pill	5		71
Progestin only		0.5	
Combined		0.1	
IUD			
Progesterone T	2.0	1.5	81
Copper T 380A	0.8	0.6	78
LNg 20	0.1	0.1	81

ParaGard® T 380A Intrauterine Copper Contraceptive

Method (1)	% of Women Experiencing an Accidental Pregnancy within the First Year of Use		% of Women Continuing Use at One Year ³
	Typical Use ¹ (2)	Perfect Use ² (3)	
Depo Provera	0.3	0.3	70
Norplant and Norplant-2	0.05	0.05	88
Female sterilization	0.5	0.5	100
Male sterilization	0.15	0.10	100
Emergency Contraceptive Pills: Treatment initiated within 72 hours after unprotected intercourse reduces the risk of pregnancy by at least 75%. ⁹			
Lactational Amenorrhea Method: LAM is a highly effective temporary method of contraception. ¹⁰			
Footnotes to Table 1 Source: Trussell J, Contraceptive efficacy. In Hatcher RA, Trussell J, Stewart F, Cates W, Stewart GK, Kowal D, Guest F, Contraceptive Technology: Seventeenth Revised Edition. New York NY: Irvington Publishers, 1998.			

- Among typical couples who initiate use of a method (not necessarily for the first time), the percentage who experience an accidental pregnancy during the first year if they do not stop use for any other reason.
- Among couples who initiate use of a method (not necessarily for the first time) and who use it perfectly (both consistently and correctly), the percentage who experience an accidental pregnancy during the first year if they do not stop use for any reason.
- Among couples attempting to avoid pregnancy, the percentage who continue to use a method for one year.
- The percents becoming pregnant in columns (2) and (3) are based on data from populations where contraception is not used and from women who cease using contraception in order to become pregnant. Among such populations, about 89% become pregnant within one year. This estimate was lowered slightly (to 85%) to represent the percentage who would become pregnant within one year among women now relying on reversible methods of contraception if they abandoned contraception altogether.
- Foams, creams, gels, vaginal suppositories, and vaginal film.
- Cervical mucus (ovulation) method supplemented by calendar in the pre-ovulatory and basal body temperature in the post-ovulatory phases.
- With spermicidal cream or jelly.
- Without spermicides.
- The treatment schedule is one dose within 72 hours after unprotected intercourse, and a second dose 12 hours after the first dose. Preven is the only dedicated product specifically marketed for emergency contraception. The Food and Drug Administration has also declared the following brands of oral contraceptive to be safe and effective for emergency contraception: Ovral (1 dose is 2 white pills), Alesse (1 dose is 5 pink pills), Nordette or Levlen (1 dose is 4 light-orange pills), Lo/Ovral (1 dose is 4 white pills), Triphasil or Tri-Levlen (1 dose is 4 yellow pills).
- However, to maintain effective protection against pregnancy, another method of contraception must be used as soon as menstruation resumes, the frequency or duration of breastfeeds is reduced, bottle feeds are introduced or the baby reaches 6 months of age.

CONTRAINDICATIONS

ParaGard® should not be placed when one or more of the following conditions exist:

- Pregnancy or suspicion of pregnancy
- Abnormalities of the uterus resulting in distortion of the uterine cavity
- Acute pelvic inflammatory disease, or current behavior suggesting a high risk for pelvic inflammatory disease
- Postpartum endometritis or postabortal endometritis in the past 3 months
- Known or suspected uterine or cervical malignancy
- Genital bleeding of unknown etiology
- Mucopurulent cervicitis
- Wilson's disease
- Allergy to any component of ParaGard®
- A previously placed IUD that has not been removed

WARNINGS

1. Intrauterine Pregnancy

If intrauterine pregnancy occurs with ParaGard® in place and the string is visible, ParaGard® should be removed because of the risk of spontaneous abortion, premature delivery, sepsis, septic shock, and, rarely, death. Removal may be followed by pregnancy loss.

If the string is not visible, and the woman decides to continue her pregnancy, check if the ParaGard® is in her uterus (for example, by ultrasound). If ParaGard® is in her uterus, warn her that there is an increased risk of spontaneous abortion and sepsis, septic shock, and, rarely, death.¹ In addition, the risk of premature labor and delivery is increased.¹

Human data about risk of birth defects from copper exposure are limited. However, studies have not detected a pattern of abnormalities, and published reports do not suggest a risk that is higher than the baseline risk for birth defects.

2. Ectopic Pregnancy

Women who become pregnant while using ParaGard® should be evaluated for ectopic pregnancy. A pregnancy that occurs with ParaGard® in place is more likely to be ectopic than a pregnancy in the general population. However, because ParaGard® prevents most pregnancies, women who use ParaGard® have a lower risk of an ectopic pregnancy than sexually active women who do not use any contraception.²⁻³

3. Pelvic Infection

Although pelvic inflammatory disease (PID) in women using IUDs is uncommon, IUDs may be associated with an increased relative risk of PID compared to other forms of contraception and to no contraception. The highest incidence of PID occurs within 20 days following insertion. Therefore, the visit following the first post-insertion menstrual period is an opportunity to assess the patient for infection, as well as to check that the IUD is in place. (See **INSTRUCTIONS FOR USE, Continuing Care.**) Since pelvic infection is most frequently associated with sexually transmitted organisms, IUDs are not recommended for women at high risk for sexual infection. Prophylactic antibiotics at the time of insertion do not appear to lower the incidence of PID.⁴ PID can have serious consequences, such as tubal damage (leading to ectopic pregnancy or infertility), hysterectomy, sepsis, and, rarely, death. It is therefore important to promptly assess and treat any woman who develops signs or symptoms of PID.

Guidelines for treatment of PID are available from the Centers for Disease Control and Prevention (CDC), Atlanta, Georgia at www.cdc.gov or 1-800-311-3435. Antibiotics are the mainstay of therapy. Most healthcare professionals also remove the IUD. The significance of actinomyces-like organisms on Papanicolaou smear in an asymptomatic IUD user is unknown.⁵⁻⁶ and so this finding alone does not always require IUD removal and treatment. However, because pelvic actinomyces is a serious infection, a woman who has *symptoms* of pelvic infection possibly due to actinomyces should be treated and have her IUD removed.

4. Immunocompromise
Women with AIDS should not have IUDs inserted unless they are clinically stable on antiretroviral therapy. Limited data suggest that asymptomatic women infected with human immunodeficiency virus may use intrauterine devices. Little is known about the use of IUDs in women who have illnesses causing serious immunocompromise. Therefore these women should be carefully monitored for infection if they choose to use an IUD. The risk of pregnancy should be weighed against the theoretical risk of infection.

5. Embedment

Partial penetration or embedment of ParaGard® in the myometrium can make removal difficult. In some cases, surgical removal may be necessary.

6. Perforation

Partial or total perforation of the uterine wall or cervix may occur rarely during placement, although it may not be detected until later. Spontaneous migration has also been reported. If perforation does occur, remove ParaGard® promptly, since the copper can lead to intraperitoneal adhesions. Intestinal penetration, intestinal obstruction, and/or damage to adjacent organs may result if an IUD is left in the peritoneal cavity. Pre-operative imaging followed by laparoscopy or laparotomy is often required to remove an IUD from the peritoneal cavity.

7. Expulsion

Expulsion can occur, usually during the menses and usually in the first few months after insertion. There is an increased risk of expulsion in the nulliparous patient. If unnoticed, an unintended pregnancy could occur.

8. Wilson's Disease

Theoretically, ParaGard® can exacerbate Wilson's disease, a rare genetic disease affecting copper excretion.

PRECAUTIONS

Patients should be counseled that this product does not protect against HIV infection (AIDS) and other sexually transmitted diseases.

1. Information for patients

Before inserting ParaGard® discuss the Patient Package Insert with the patient, and give her time to read the information. Discuss any questions she may have concerning ParaGard® as well as other methods of contraception. Instruct her to promptly report symptoms of infection, pregnancy, or missing strings.

2. Insertion precautions, continuing care, and removal.

(See **INSTRUCTIONS FOR USE.**)

3. Vaginal bleeding

In the 2 largest clinical trials with ParaGard® (see **ADVERSE REACTIONS, Table 2**), menstrual changes were the most common medical reason for discontinuation of ParaGard®. Discontinuation rates for pain and bleeding combined are highest in the first year of use and diminish thereafter. The percentage of women who discontinued ParaGard® because of bleeding problems or pain during these studies ranged from 11.9% in the first year to 2.2% in year 9. Women complaining of heavy vaginal bleeding should be evaluated and treated, and may need to discontinue ParaGard®. (See **ADVERSE REACTIONS.**)

4. Vasovagal reactions, including fainting

Some women have vasovagal reactions immediately after insertion. Hence, patients should remain supine until feeling well and should be cautious when getting up.

5. Expulsion following placement after a birth or abortion

ParaGard® has been placed immediately after delivery, although risk of expulsion may be higher than when ParaGard® is placed at times unrelated to delivery.⁷ However, unless done immediately postpartum, insertion should be delayed to the second postpartum month because insertion during the first postpartum month (except for immediately after delivery) has been associated with increased risk of perforation.⁸

ParaGard® can be placed immediately after abortion, although immediate placement has a slightly higher risk of expulsion than placement at other times.⁹ Placement after second trimester abortion is associated with a higher risk of expulsion than placement after the first trimester abortion.⁹

6. Magnetic resonance imaging (MRI)

Limited data suggest that MRI at the level of 1.5 Tesla is acceptable in women using ParaGard®. One study examined the effect of MRI on the CU-7® Intrauterine Copper Contraceptive and Lippes Loop™ intrauterine devices. Neither device moved under the influence of the magnetic field or heated during the spin-echo sequences usually employed for pelvic imaging.¹⁰ An in vitro study did not detect movement or temperature change when ParaGard® was subjected to MRI.¹¹

7. Medical diathermy

Theoretically, medical (non-surgical) diathermy (short-wave and microwave heat therapy) in a patient with a metal-containing IUD may cause heat injury to the surrounding tissue. However, a small study of eight women did not detect a significant elevation of intrauterine temperature when diathermy was performed in the presence of a copper IUD.¹²

8. Pregnancy

ParaGard® is contraindicated during pregnancy. (See **CONTRAINDICATIONS and WARNINGS.**)

9. Nursing mothers

Nursing mothers may use ParaGard®. No difference has been detected in concentration of copper in human milk before and after insertion of copper IUDs. The literature is conflicting, but limited data suggest that there may be an increased risk of perforation and expulsion if a woman is lactating.¹³

10. Pediatric use

ParaGard® is not indicated before menarche. Safety and efficacy have been established in women over 16 years old.

ADVERSE REACTIONS

The most serious adverse events associated with intrauterine contraception are discussed in **WARNINGS** and **PRECAUTIONS**. These include:

Intrauterine pregnancy	Pelvic infection
Septic abortion	Perforation
Ectopic pregnancy	Embedment

Table 2 shows discontinuation rates from two clinical studies by adverse event and year.

Table 2. Summary of Rates (No. per 100 Subjects) by Year for Adverse Events Causing Discontinuation

Adverse Event	Year									
	1	2	3	4	5	6	7	8	9	10
Pregnancy	0.7	0.3	0.6	0.2	0.3	0.2	0.0	0.4	0.0	0.0
Expulsion	5.7	2.5	1.6	1.2	0.3	0.0	0.6	1.7	0.2	0.4
Bleeding/Pain	11.9	9.8	7.0	3.5	3.7	2.7	3.0	2.5	2.2	3.7
Other Medical Event	2.5	2.1	1.6	1.7	0.1	0.3	1.0	0.4	0.7	0.3
No. of Women at Start of Year	4932	3149	2018	1121	872	621	563	483	423	325

*Rates were calculated by weighting the annual rates by the number of subjects starting each year for each of the Population Council (3,536 subjects) and the World Health Organization (1,396 subjects) trials.

The following adverse events have also been observed. These are listed alphabetically and not by order of frequency or severity.

Anemia	Menstrual flow, prolonged
Backache	Menstrual spotting
Dysmenorrhea	Pain and cramping
Dyspareunia	Urticarial allergic skin reaction
Expulsion, complete or partial	Vaginitis
Leukorrhea	

INSTRUCTIONS FOR USE

The placement technique for ParaGard® is different from that used for other IUDs. Therefore, the clinician should be familiar with the following instructions.

ParaGard® may be placed at any time during the cycle when the clinician is reasonably certain the patient is not pregnant. For information about timing of postpartum and postabortion insertions, see **PRECAUTIONS**.

A single ParaGard® should be placed at the fundus of the uterine cavity. ParaGard® should be removed on or before 10 years from the date of insertion.

Before Placement:

1. Make sure that the patient is an appropriate candidate for ParaGard® and that she has read the Patient Package Insert.
2. Use of an analgesic before insertion is at the discretion of the patient and the clinician.
3. Establish the size and position of the uterus by pelvic examination.
4. Insert a speculum and cleanse the vagina and cervix with an antiseptic solution.
5. Apply a tenaculum to the cervix and use gentle traction to align the cervical canal with the uterine cavity.
6. Gently insert a sterile sound to measure the depth of the uterine cavity.

7. The uterus should sound to a depth of 6 to 9 cm except when inserting ParaGard® immediately post-abortion or post-partum. Insertion of ParaGard® into a uterine cavity measuring less than 6 cm may increase the incidence of expulsion, bleeding, pain, and perforation. If you encounter cervical stenosis, avoid undue force. Dilators may be helpful in this situation.

How to Load and Place ParaGard®:

Do not bend the arms of ParaGard® earlier than 5 minutes before it is to be placed in the uterus. Use aseptic technique when handling ParaGard® and the part of the insertion tube that will enter the uterus.

STEP 1

Load ParaGard® into the insertion tube by folding the two horizontal arms of ParaGard® against the stem and push the tips of the arms securely into the inserter tube.

If you do not have sterile gloves, you can do STEPS 1 and 2 while ParaGard® is in the sterile package. First, place the package face up on a clean surface. Next, open at the bottom end (where arrow says OPEN). Pull the solid white rod partially from the package so it will not interfere with assembly. Place thumb and index finger on top of package on ends of the horizontal arms. Use other hand to push insertion tube against arms of ParaGard® (shown by arrow in Fig. 1). This will start bending the T arms.

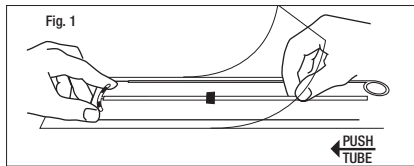

STEP 2

Bring the thumb and index finger closer together to continue bending the arms until they are alongside the stem. Use the other hand to withdraw the insertion tube just enough so that the insertion tube can be pushed and rotated onto the tips of the arms. Your goal is to secure the tips of the arms inside the tube (Fig. 2). Insert the arms no further than necessary to insure retention. Introduce the solid white rod into the insertion tube from the bottom, alongside the threads, until it touches the bottom of the ParaGard®.

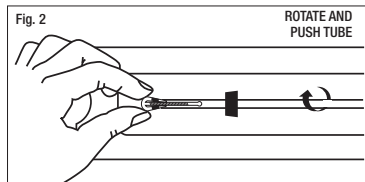

STEP 3

Grasp the insertion tube at the open end of the package; adjust the blue flange so that the distance from the top of the ParaGard® (where it protrudes from the inserter) to the blue flange is the same as the uterine depth that you measured with the sound. Rotate the insertion tube so that the horizontal arms of the T and the long axis of the blue flange lie in the same horizontal plane (Fig. 3). Now pass the loaded insertion tube through the cervical canal until ParaGard® just touches the fundus of the uterus. The blue flange should be at the cervix in the horizontal plane.

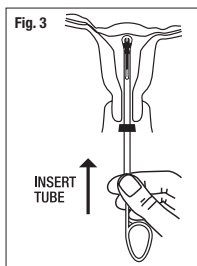

STEP 4

To release the arms of ParaGard®, hold the solid white rod steady and withdraw the insertion tube no more than one centimeter. This releases the arms of ParaGard® high in the uterine fundus (Fig. 4).

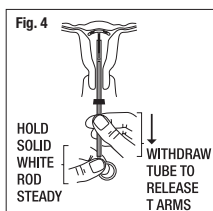

STEP 5

Gently and carefully move the insertion tube upward toward the top of the uterus, until slight resistance is felt. This will ensure placement of the T at the highest possible position within the uterus (Fig. 5).

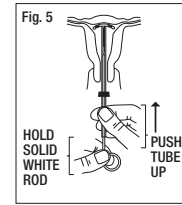

STEP 6

Hold the insertion tube steady and withdraw the solid white rod (Fig. 6).

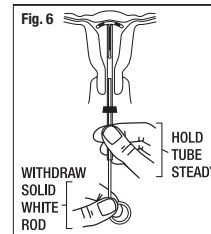

STEP 7

Gently and slowly withdraw the insertion tube from the cervical canal. Only the threads should be visible protruding from the cervix. (Fig. 7). Trim the threads so that 3 to 4 cm protrude into the vagina. Note the length of the threads in the patient's records.

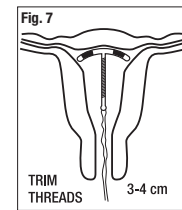

If you suspect that ParaGard® is not in the correct position, check placement (with ultrasound, if necessary). If ParaGard® is not positioned completely within the uterus, remove it and replace it with a new ParaGard®. Do not reinsert an expelled or partially expelled ParaGard®.

CAUTION

Instrumentation of the cervical os may result in vasovagal reactions, including fainting. Have the patient remain supine until she feels well, and have her get up with caution.

Continuing Care:

Following placement, examine the patient after her first menses to confirm that ParaGard® is still in place. **You should be able to see or feel only the threads.** If ParaGard® has been partially or completely expelled, remove it. You can place a new ParaGard® if the patient desires and if she is not pregnant. Do not reinsert a used ParaGard®.

Evaluate the patient promptly if she complains of any of the following:

- Abdominal or pelvic pain, cramping, or tenderness; malodorous discharge; bleeding; fever
- A missed period

(See **WARNINGS, Pelvic Infection, Intrauterine Pregnancy and Ectopic Pregnancy.**)

The length of the visible threads may change with time. However, no action is needed unless you suspect partial expulsion, perforation, or pregnancy.

If you cannot find the threads in the vagina, check that ParaGard® is still in the uterus. The threads can retract into the uterus or break, or ParaGard® can break, perforate the uterus, or be expelled. Gentle probing of the cavity, radiography, or sonography may be required to locate the IUD.

If there is evidence of partial expulsion, perforation, or breakage, remove ParaGard®.

How to Remove ParaGard®

Remove ParaGard® with forceps, pulling gently on the exposed threads. The arms of ParaGard® will fold upwards as it is withdrawn from the uterus. You may immediately insert a new ParaGard® if the patient requests it and has no contraindications.

Embedment or breakage of ParaGard® in the myometrium can make removal difficult. Analgesia, paracervical anesthesia, and cervical dilation may assist in removing an embedded ParaGard®. An alligator forceps or other grasping instrument may be helpful. Hysteroscopy may also be helpful.

HOW SUPPLIED

ParaGard® is available in cartons of 1 (one) sterile unit (NDC 51285-204-01). Each ParaGard® is packaged together with an insertion tube and solid white rod in a Tyvek® polyethylene pouch.

REFERENCES

1. Tatum HJ, Schmidt FH, Jain AK. Management and outcome of pregnancies associated with the Copper T intrauterine contraceptive device. *Am J Obstet Gynecol.* 1976;126:869-879.
2. Sivin I. Dose- and age-dependent ectopic pregnancy risks with intrauterine contraception. *Obstet Gynecol.* 1991;78:291-298.
3. Franks AL, Beral V, Cates W Jr, Hogue CJR. Contraception and ectopic pregnancy risk. *Am J Obstet Gynecol.* 1990;163:1120-1123.
4. Grimes DA, Schulz KF. Prophylactic antibiotics for intrauterine device insertion: a meta-analysis of the randomized controlled trials. *Contraception.* 1999;60:57-63.
5. Lippes J. Pelvic actinomycosis: a review and preliminary look at prevalence. *Am J Obstet Gynecol.* 1999;180:265-269.
6. Pettiti DB, Yamamoto D, Morgenstern N. Factors associated with actinomycosis-like organisms on Papanicolaou smear in users of intrauterine contraceptive devices. *Am J Obstet Gynecol.* 1983;145:338-341.
7. Grimes D, Schulz K, van Vliet H, Stanwood N. Immediate post-partum insertion of intrauterine devices: a Cochrane review. *Hum Reprod.* 2002;17:549-554.
8. Cole LP, Edelman DA, Potts DM, Wheeler RG, Lafe LE. Postpartum insertion of modified intrauterine devices. *J Reprod Med.* 1984;29:677-682.
9. Grimes DA, Schulz KF, Stanwood N. Immediate post-abortion insertion of intrauterine devices. (Cochrane Review). In: *The Cochrane Library*, Issue 2, 2003. Oxford: Update Software.
10. Hess T, Stepanow B, Knopp MV. Magnetic resonance imaging: safety of intrauterine contraceptive devices during MR imaging. *Eur Radiol.* 1996;6:66-68.
11. Mark AS, Hricak H. Intrauterine contraceptive devices: MR imaging. *Radiology.* 1987;162:311-314.
12. Heick A., Espersen T., Pedersen HL, Raahauge J: Is diathermy safe in women with copper-bearing IUDs? *Acta Obstet Gynecol Scand.* 1991;70(2):153-5.
13. Rodrigues da Cunha AC, Dorea JG, Cantuaria AA. Intrauterine device and maternal copper metabolism during lactation. *Contraception* 2001;63:37-9.

INFORMATION FOR PATIENTS

ParaGard® T 380A Intrauterine Copper Contraceptive

ParaGard® T 380A Intrauterine Copper Contraceptive is used to prevent pregnancy. It does not protect against HIV infection (AIDS) and other sexually transmitted diseases.

It is important for you to understand this brochure and discuss it with your healthcare provider before choosing ParaGard® T 380A Intrauterine Copper Contraceptive (ParaGard®). You should also learn about other birth control methods that may be an option for you.

What is ParaGard®?

ParaGard® is a copper-releasing device that is placed in your uterus to prevent pregnancy for up to 10 years.

ParaGard® is made of white plastic in the shape of a "T." Copper is wrapped around the stem and arms of the "T." Two white threads are attached to the stem of the "T." The threads are the only part of ParaGard® that you can feel when ParaGard® is in your uterus. ParaGard® and its components do not contain latex.

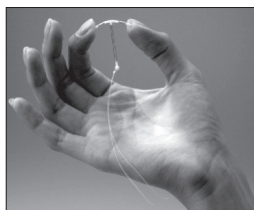

How long can I keep ParaGard® in place?

You can keep ParaGard® in your uterus for up to 10 years. After 10 years, you should have ParaGard® removed by your healthcare provider. If you wish and if it is still right for you, you may get a new ParaGard® during the same visit.

What if I change my mind and want to become pregnant?

Your healthcare provider can remove ParaGard® at any time. After discontinuation of ParaGard®, its contraceptive effect is reversed.

How does ParaGard® work?

Ideas about how ParaGard® works include preventing sperm from reaching the egg, preventing sperm from fertilizing the egg, and possibly preventing the egg from attaching (implanting) in the uterus. ParaGard® does not stop your ovaries from making an egg (ovulating) each month.

How well does ParaGard® work?

Fewer than 1 in 100 women become pregnant each year while using ParaGard®. The table below shows the chance of getting pregnant using different types of birth control. The numbers show *typical* use, which includes people who don't always use birth control correctly.

Number of women out of 100 women who are likely to get pregnant over one year

Method of birth control	Pregnancies per 100 women over one year
No Method	85
Spermicides	26
Periodic abstinence	25
Cap with Spermicides	20
Vaginal Sponge	20 to 40
Diaphragm with Spermicides	20
Withdrawal	19
Condom without spermicides (female)	21
Condom without spermicides (male)	14
Oral Contraceptives	5
IUDs, Depo-Provera, implants, sterilization	less than 1

Who might use ParaGard®?

You might choose ParaGard® if you

- need birth control that is very effective
- need birth control that stops working when you stop using it
- need birth control that is easy to use

Who should not use ParaGard®?

You should not use ParaGard® if you

- Might be pregnant
- Have a uterus that is abnormally shaped inside
- Have a pelvic infection called pelvic inflammatory disease (PID) or have current behavior that puts you at high risk of PID (for example, because you are having sex with several men, or your partner is having sex with other women)
- Have had an infection in your uterus after a pregnancy or abortion in the past 3 months
- Have cancer of the uterus or cervix
- Have unexplained bleeding from your vagina
- Have an infection in your cervix
- Have Wilson's disease (a disorder in how the body handles copper)
- Are allergic to anything in ParaGard®
- Already have an intrauterine contraceptive in your uterus

How is ParaGard® placed in the uterus?

ParaGard® is placed in your uterus during an office visit. Your healthcare provider first examines you to find the position of your uterus. Next, he or she will cleanse your vagina and cervix, measure your uterus, and then slide a plastic tube containing ParaGard® into your uterus. The tube is removed, leaving ParaGard® inside your uterus. Two white threads extend into your vagina. The threads are trimmed so they are just long enough for you to feel with your fingers when doing a self-check. As ParaGard® goes in, you may feel cramping or pinching. Some women feel faint, nauseated, or dizzy for a few minutes afterwards. Your healthcare provider may ask you to lie down for a while and to get up slowly.

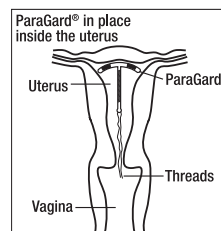

How do I check that ParaGard® is in my uterus?

Visit your healthcare provider for a check-up about one month after placement to make sure ParaGard® is still in your uterus.

You can also check to make sure that ParaGard® is still in your uterus by reaching up to the top of your vagina with clean fingers to feel the two threads. Do not pull on the threads.

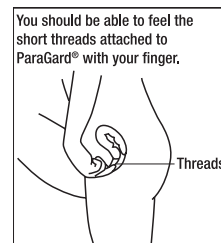

If you cannot feel the threads, ask your healthcare provider to check if ParaGard® is in the right place. If you can feel more of ParaGard® than just the threads, ParaGard® is *not* in the right place. If you can't see your healthcare provider right away, use an additional birth control method. If ParaGard® is in the wrong place, your chances of getting pregnant are increased. It is a good habit for you to check that ParaGard® is in place once a month.

You may use tampons when you are using ParaGard®.

What if I become pregnant while using ParaGard®?

If you think you are pregnant, contact your healthcare professional *right away*. If you are pregnant and ParaGard® is in your uterus, you may get a severe infection or shock, have a miscarriage or premature labor and delivery, or even die. Because of these risks, your healthcare provider will recommend that you have ParaGard® removed, even though removal may cause miscarriage.

If you continue a pregnancy with ParaGard® in place, see your healthcare provider regularly. Contact your healthcare provider right away if you get fever, chills, cramping, pain, bleeding, flu-like symptoms, or an unusual, bad smelling vaginal discharge. A pregnancy with ParaGard® in place has a greater than usual chance of being ectopic (outside your uterus). Ectopic pregnancy is an emergency that may require surgery. An ectopic pregnancy can cause internal bleeding, infertility, and death. Unusual vaginal bleeding or abdominal pain may be signs of an ectopic pregnancy. Copper in ParaGard® does not seem to cause birth defects.

What side effects can I expect with ParaGard®?

The most common side effects of ParaGard® are heavier, longer periods and spotting between periods; most of these side effects diminish after 2-3 months. However, if your menstrual flow continues to be heavy or long, or spotting continues, contact your healthcare provider.

Infrequently, serious side effects may occur:

- Pelvic inflammatory disease (PID): Uncommonly, ParaGard® and other IUDs are associated with PID. PID is an infection of the uterus, tubes, and nearby organs. PID is most likely to occur in the first 20 days after placement. You have a higher chance of getting PID if you or your partner have sex with more than one person. PID is treated with antibiotics. However, PID can cause serious problems such as infertility, ectopic pregnancy, and chronic pelvic pain. Rarely, PID may even cause death. More serious cases of PID require surgery or a hysterectomy (removal of the uterus). Contact your healthcare provider right away if you have any of the signs of PID: abdominal or pelvic pain, painful sex, unusual or bad smelling vaginal discharge, chills, heavy bleeding, or fever.
- Difficult removals: Occasionally ParaGard® may be hard to remove because it is stuck in the uterus. Surgery may sometimes be needed to remove ParaGard®.
- Perforation: Rarely, ParaGard® goes through the wall of the uterus, especially during placement. This is called perforation. If ParaGard® perforates the uterus, it should be removed. Surgery may be needed. Perforation can cause infection, scarring, or damage to other organs. If ParaGard® perforates the uterus, you are not protected from pregnancy.
- Expulsion: ParaGard® may partially or completely fall out of the uterus. This is called expulsion. Women who have never been pregnant may be more likely to expel ParaGard® than women who have been pregnant before. If you think that ParaGard® has partly or completely fallen out, use an additional birth control method, such as a condom and call your healthcare provider.

You may have other side effects with ParaGard®. For example, you may have anemia (low blood count), backache, pain during sex, menstrual cramps, allergic reaction, vaginal infection, vaginal discharge, faintness, or pain. This is not a complete list of possible side effects. If you have questions about a side effect, check with your healthcare provider.

When should I call my healthcare provider?

Call your healthcare provider if you have any concerns about ParaGard®. Be sure to call if you

- Think you are pregnant
- Have pelvic pain or pain during sex
- Have unusual vaginal discharge or genital sores
- Have unexplained fever
- Might be exposed to sexually transmitted diseases (STDs)
- Cannot feel ParaGard®'s threads or can feel the threads are much longer
- Can feel any other part of the ParaGard® besides the threads
- Become HIV positive or your partner becomes HIV positive
- Have severe or prolonged vaginal bleeding
- Miss a menstrual period

General advice about prescription medicines

This brochure summarizes the most important information about ParaGard®. If you would like more information, talk with your healthcare provider. You can ask your healthcare provider for information about ParaGard® that is written for healthcare professionals.

Checklist

This checklist will help you and your healthcare provider discuss the pros and cons of ParaGard® for you. Do you have any of the following conditions?

	Yes	No	Don't know
Abnormal Pap smear	<input type="checkbox"/>	<input type="checkbox"/>	<input type="checkbox"/>
Abnormalities of the uterus	<input type="checkbox"/>	<input type="checkbox"/>	<input type="checkbox"/>
Allergy to copper	<input type="checkbox"/>	<input type="checkbox"/>	<input type="checkbox"/>
Anemia or blood clotting problems	<input type="checkbox"/>	<input type="checkbox"/>	<input type="checkbox"/>
Bleeding between periods	<input type="checkbox"/>	<input type="checkbox"/>	<input type="checkbox"/>
Cancer of the uterus or cervix	<input type="checkbox"/>	<input type="checkbox"/>	<input type="checkbox"/>
Fainting attacks	<input type="checkbox"/>	<input type="checkbox"/>	<input type="checkbox"/>

<i>continued</i>	Yes	No	Don't know
Genital sores	<input type="checkbox"/>	<input type="checkbox"/>	<input type="checkbox"/>
Heavy menstrual flow	<input type="checkbox"/>	<input type="checkbox"/>	<input type="checkbox"/>
HIV or AIDS	<input type="checkbox"/>	<input type="checkbox"/>	<input type="checkbox"/>
Infection of the uterus or cervix	<input type="checkbox"/>	<input type="checkbox"/>	<input type="checkbox"/>
IUD in place now or in the past	<input type="checkbox"/>	<input type="checkbox"/>	<input type="checkbox"/>
More than one sexual partner	<input type="checkbox"/>	<input type="checkbox"/>	<input type="checkbox"/>
Pelvic infection (PID)	<input type="checkbox"/>	<input type="checkbox"/>	<input type="checkbox"/>
Possible pregnancy	<input type="checkbox"/>	<input type="checkbox"/>	<input type="checkbox"/>
Repeated episodes of pelvic infection (PID)	<input type="checkbox"/>	<input type="checkbox"/>	<input type="checkbox"/>
Serious infection following a pregnancy or abortion in the past 3 months	<input type="checkbox"/>	<input type="checkbox"/>	<input type="checkbox"/>
Severe menstrual cramps	<input type="checkbox"/>	<input type="checkbox"/>	<input type="checkbox"/>
Sexual partner who has more than one sexual partner	<input type="checkbox"/>	<input type="checkbox"/>	<input type="checkbox"/>
Sexually transmitted disease (STD) such as gonorrhea or chlamydia	<input type="checkbox"/>	<input type="checkbox"/>	<input type="checkbox"/>
Wilson's disease	<input type="checkbox"/>	<input type="checkbox"/>	<input type="checkbox"/>



Teva Women's Health, Inc.
A Subsidiary of Teva Pharmaceuticals USA, Inc.
North Wales, PA 19454

Rev. 9/2014

P/N 1017005

PAR-40817